

1 UPS 25-60 130



: 96281476

, PES/PP.

1-

: 2 .. 110 °C
 20 °C
 998.2 / 3

TF

110
 : VDE,EAC

EN-JL1030
 ASTM 30 B
 , PES/PP

.T

80 0C: 40 °C

10
 G 1 1/2
 PN 10
 130

C : 2.5
 1: 50
 2: 60
 3: 70
 : 50 Hz
 : 1 x 230 V
 1: 0.22 A
 2: 0.27 A
 3: 0.3 A
 : 2.5
 (IEC 34-5): IP44
 (IEC 85): F
 :
 :
 : 2.4
 : 2.6
 : 0.004 3

96281476 UPS 25-60 130 50

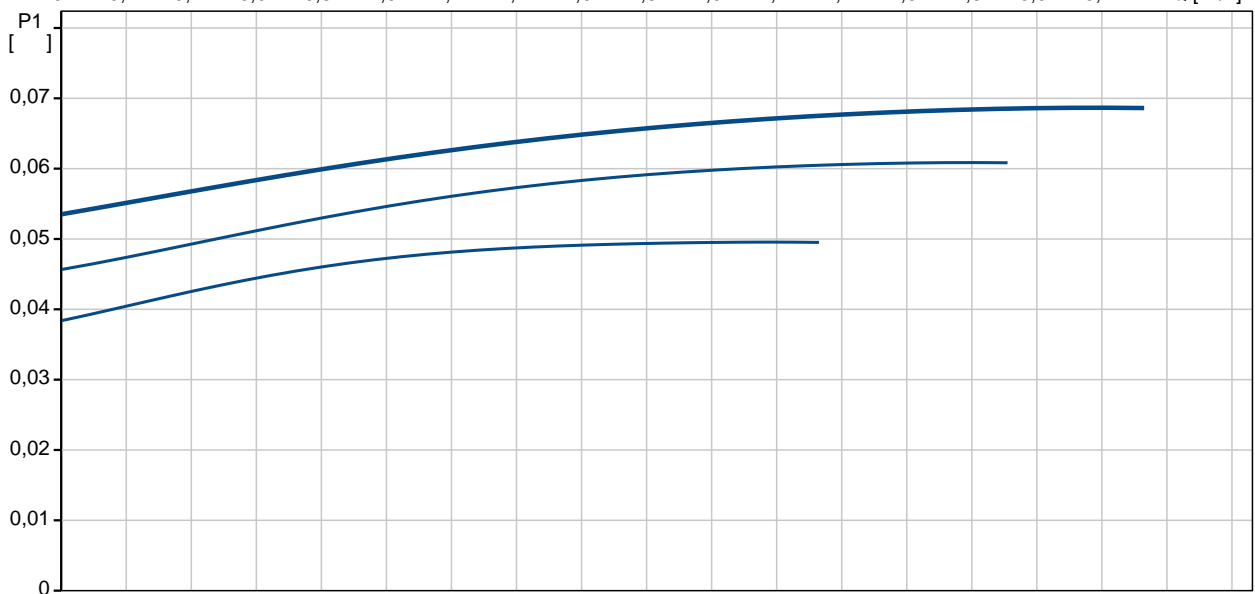
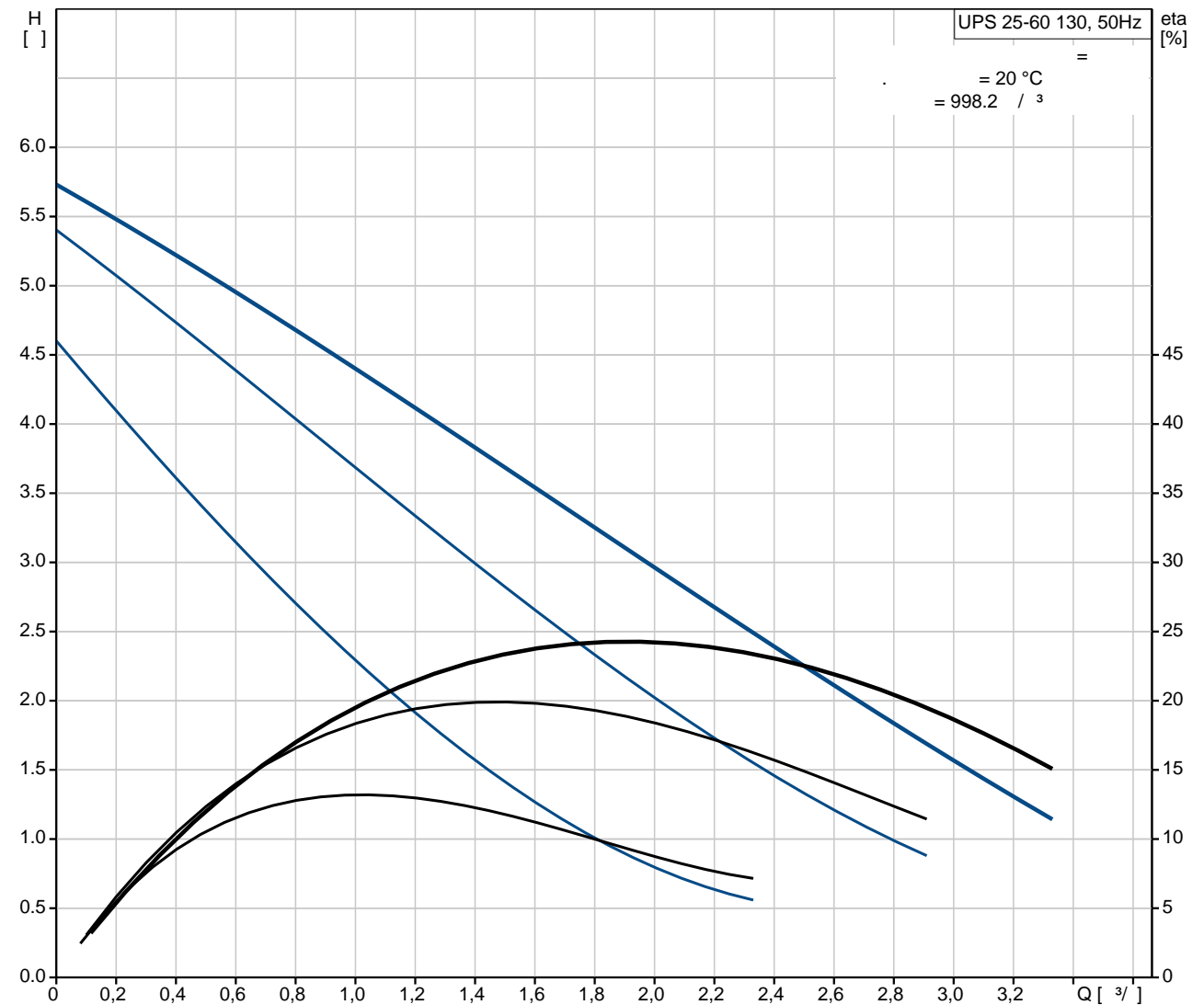

UPS 25-60 130	
EAN : 96281476	
5700830383186	
TF :	3
	60
	110
	VDE,EAC
EN-JL1030	
ASTM 30 B	
, PES/PP	
.T	40 °C
80 OC:	
	10
	G 1 1/2
	PN 10
	130
	2 .. 110 °C
	20 °C
	998.2 / ³
C :	2.5
1:	50
2:	60
3:	70
	50 Hz
	1 x 230 V
1:	0.22 A
2:	0.27 A
3:	0.3 A
	2.5
(IEC 34-5):	IP44
(IEC 85):	F
	9H
	2.4
	2.6
	0.004 3

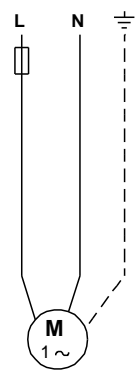
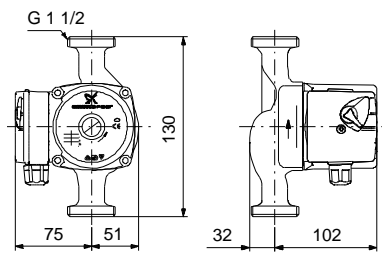
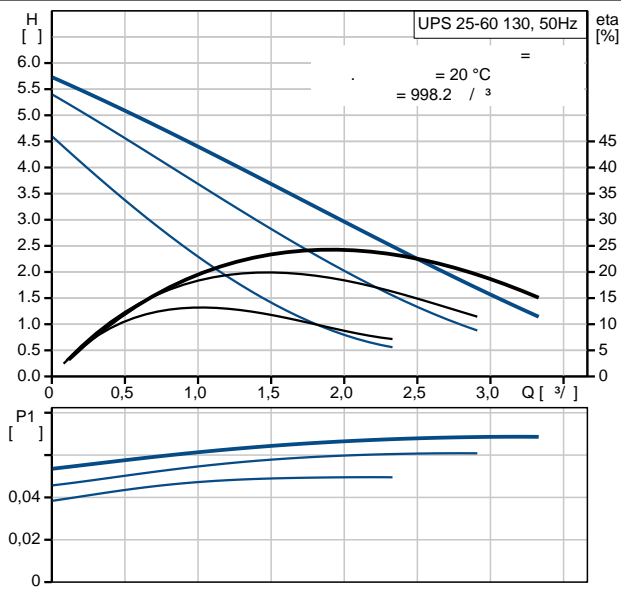

96281476 UPS 25-60 130 50

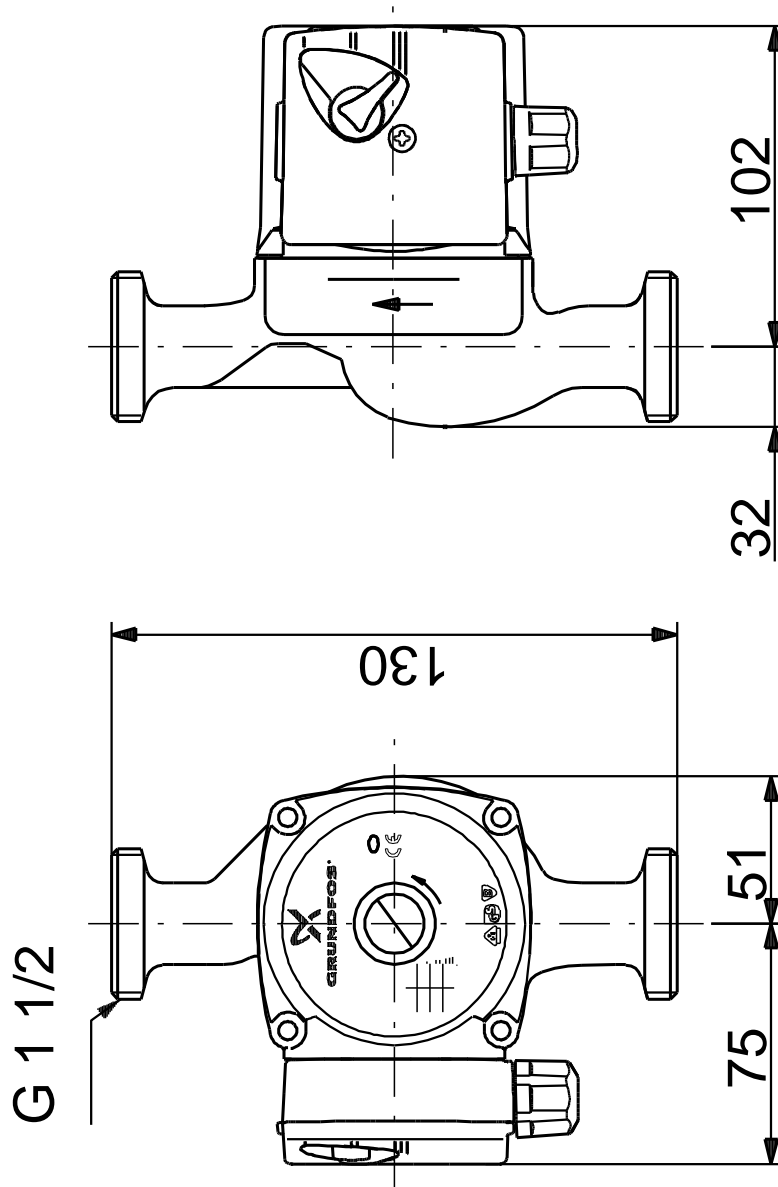

96281476 UPS 25-60 130 50

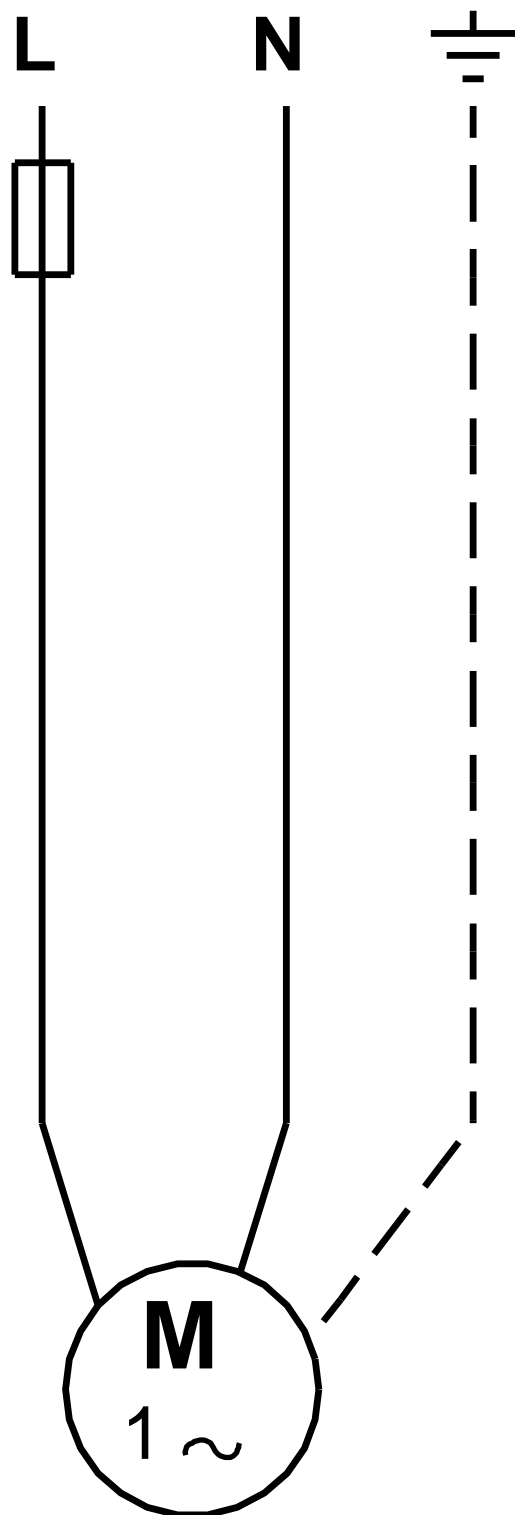

!

[],