



# SCALA2



<http://qr.grundfos.com/i/scala2install>

be  
think  
innovate

**GRUNDFOS** 



PN10:  
Max. 10 bar/1.0 MPa



- Voltage
- Ambient temperatur



Min./Max.  
0 °C - + 45 °C/  
32 °F - + 113 °F

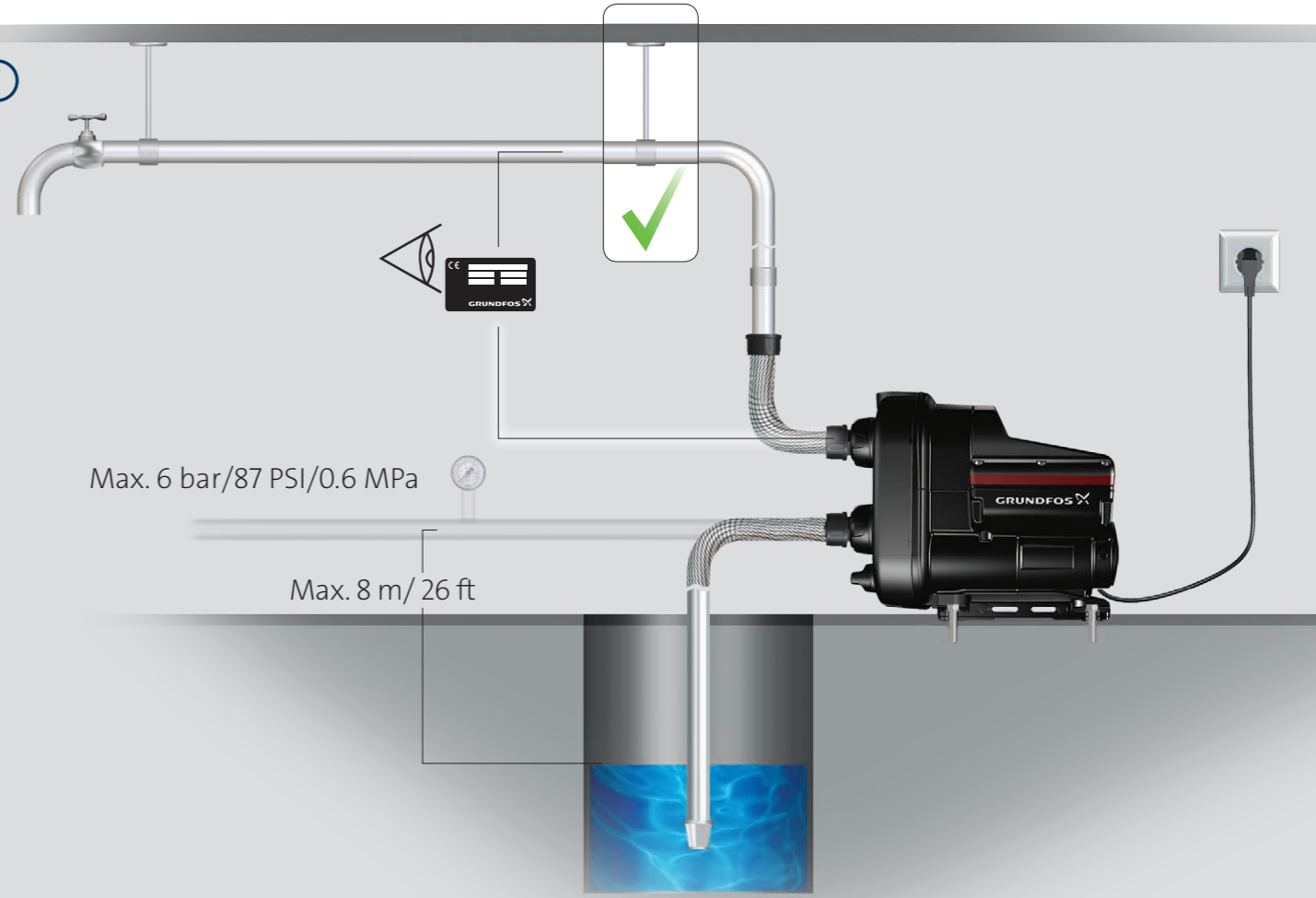
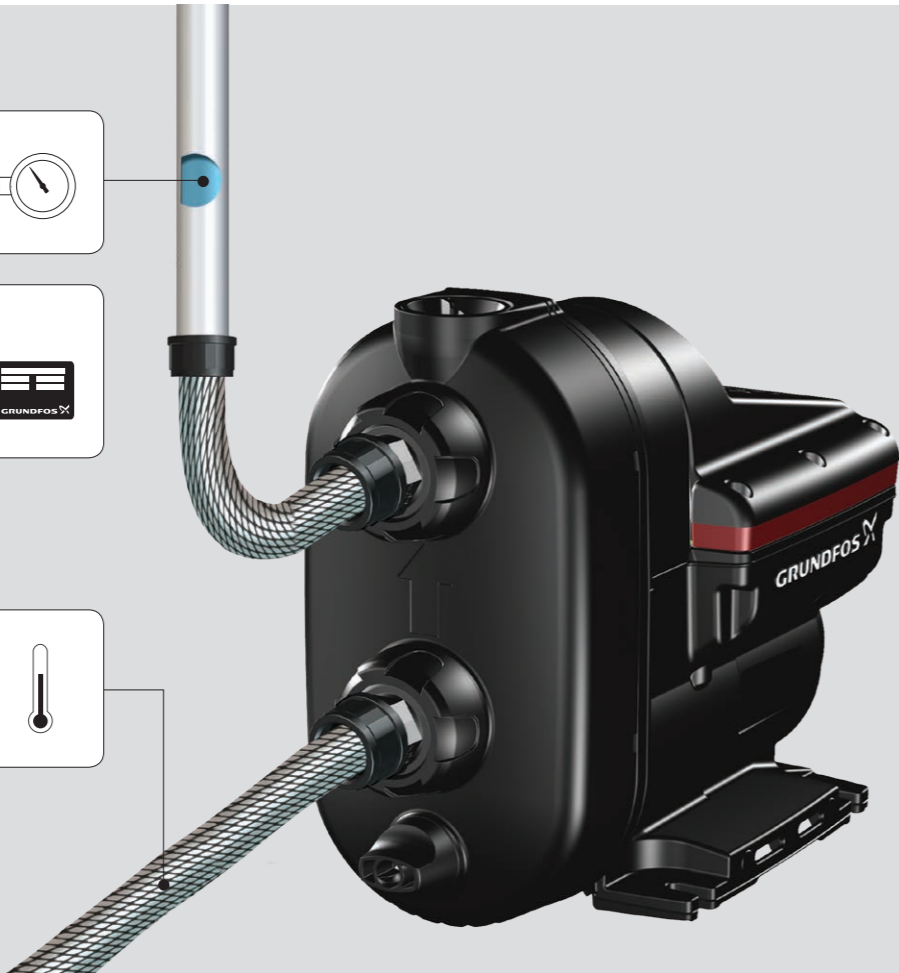

Max. 6 bar/87 PSI/0.6 MPa



Max. 8 m/ 26 ft

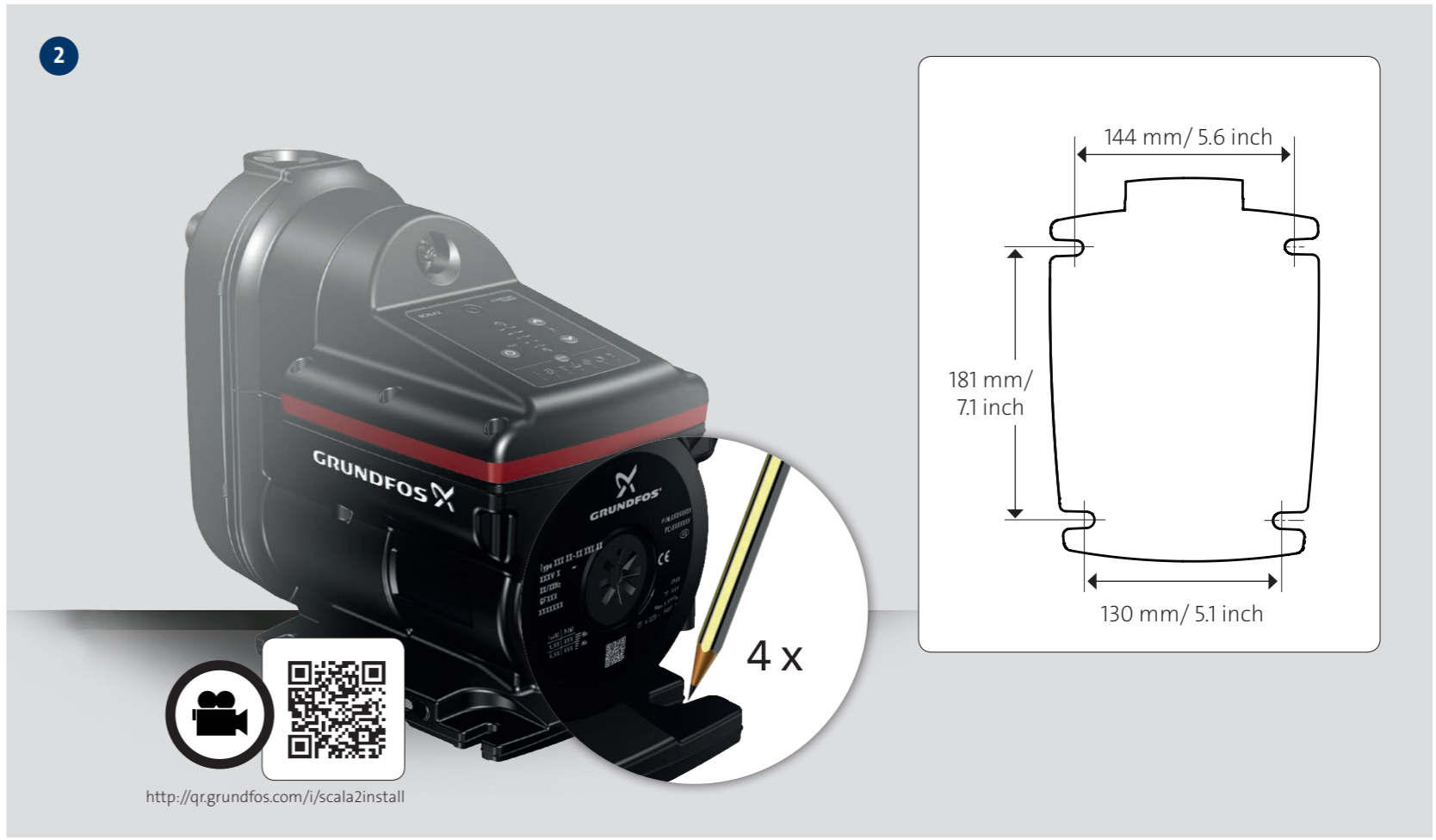
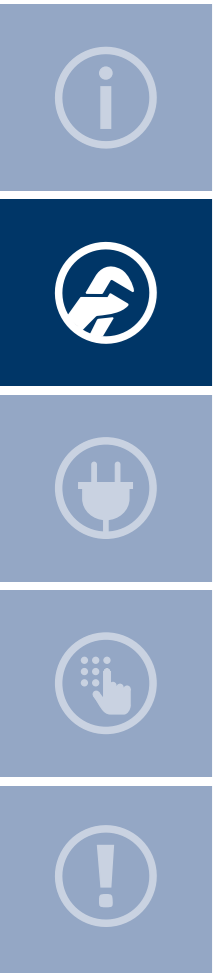

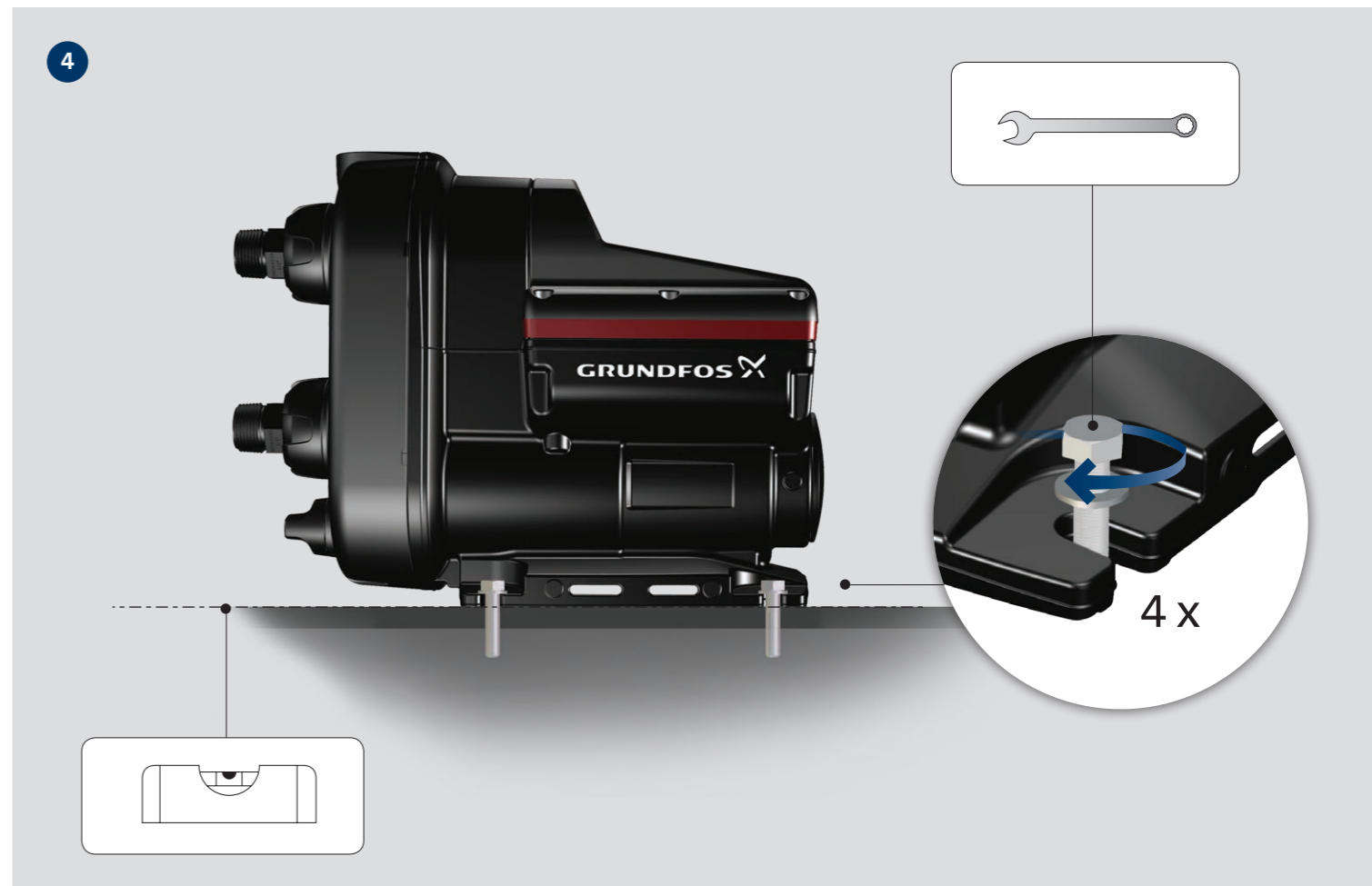
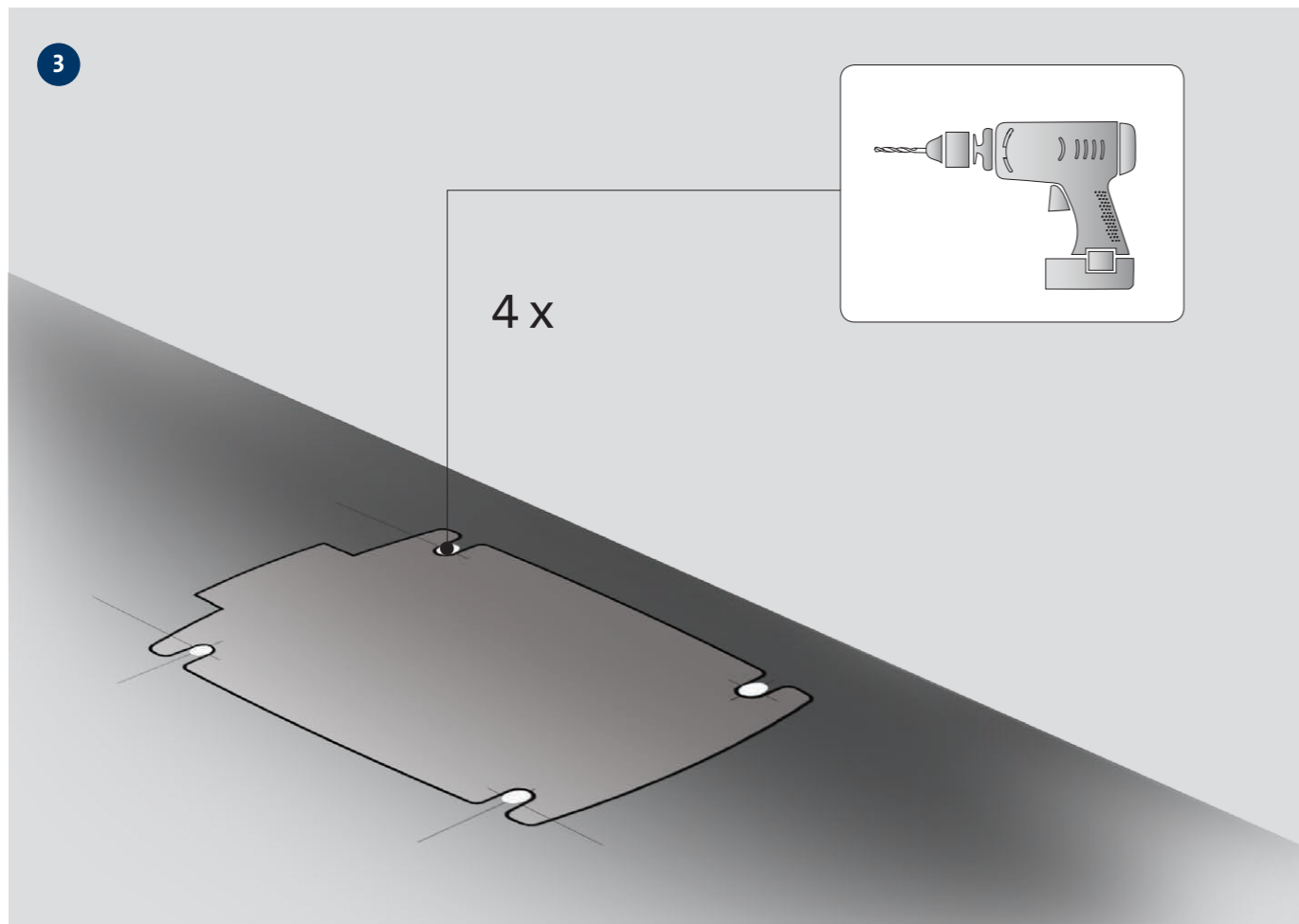
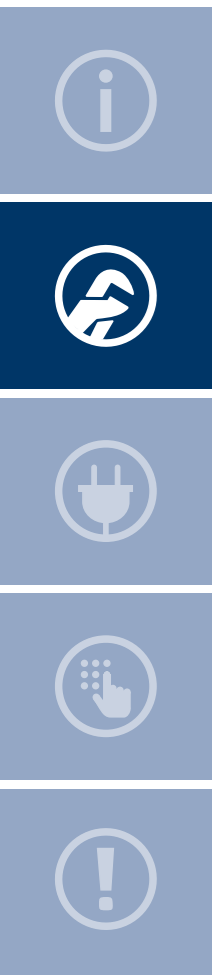

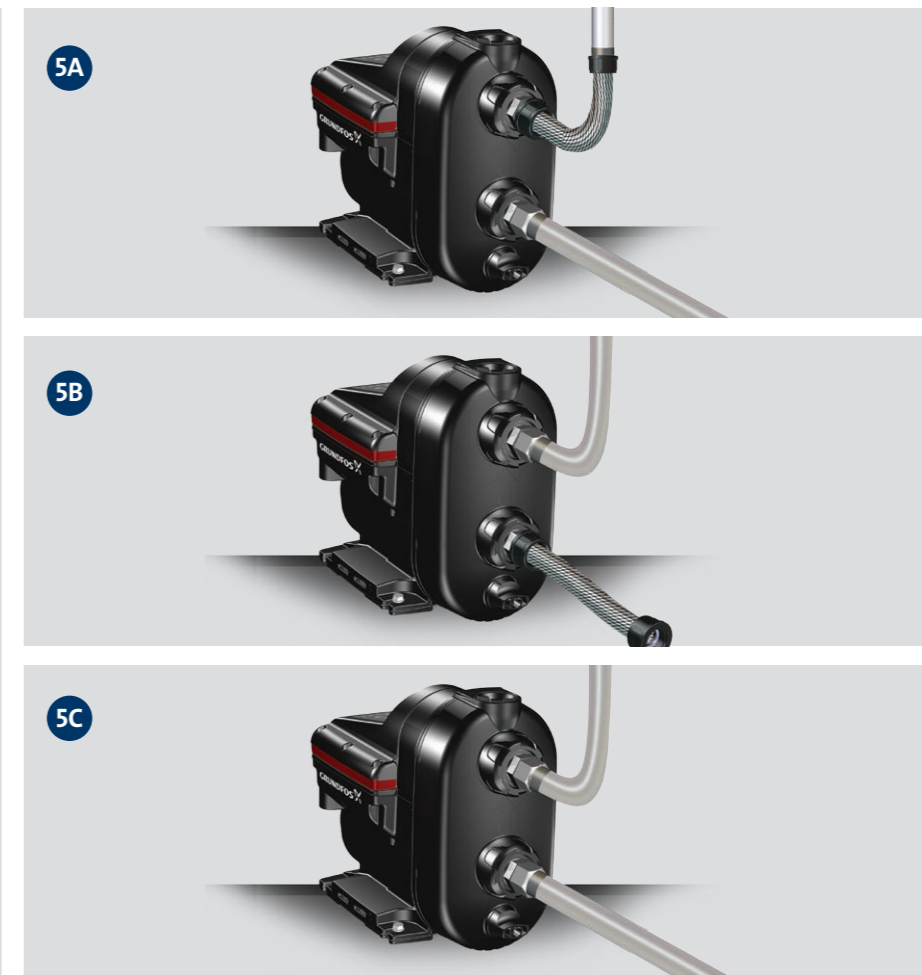
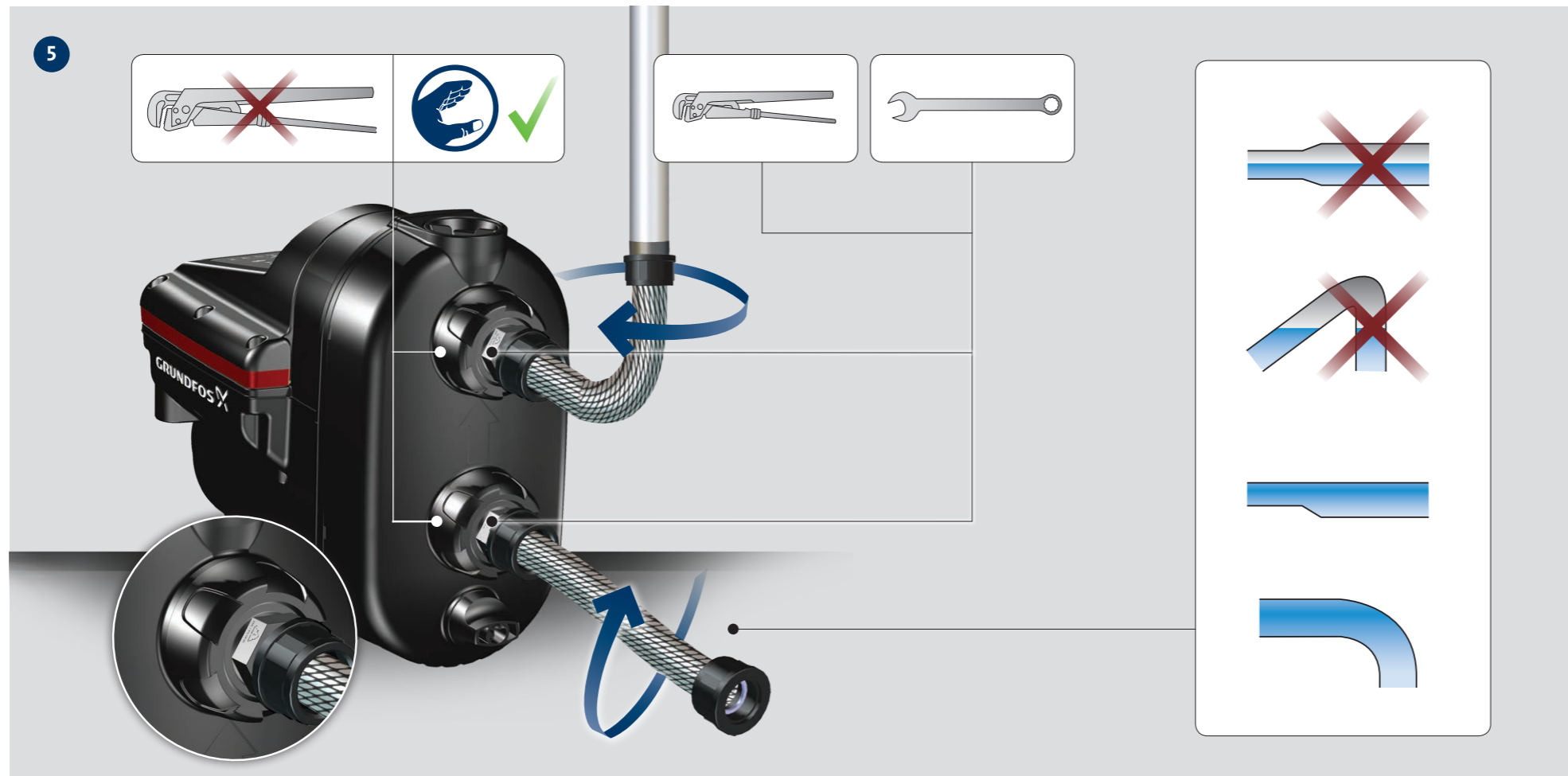
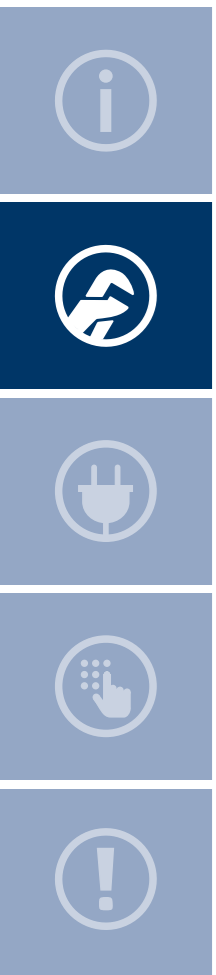

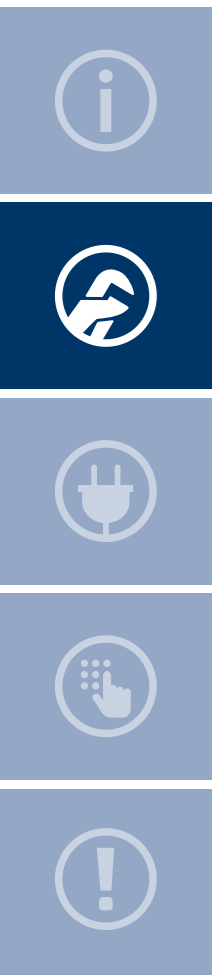

6

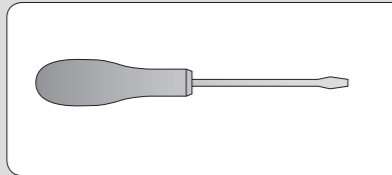

<http://qr.grundfos.com/i/scala2install>

7



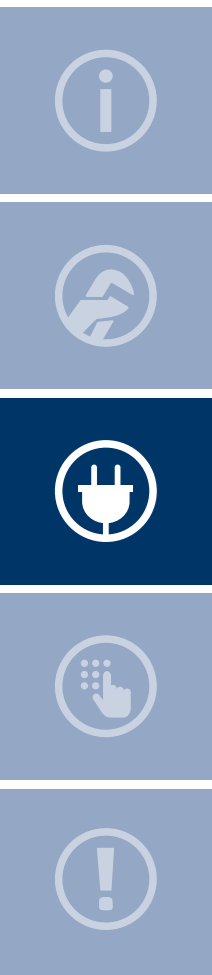

8

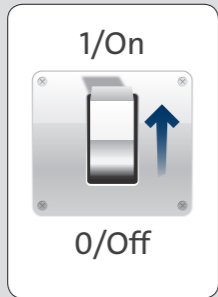
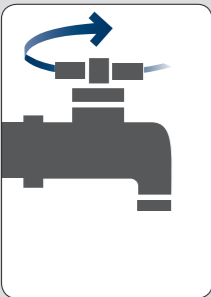

9

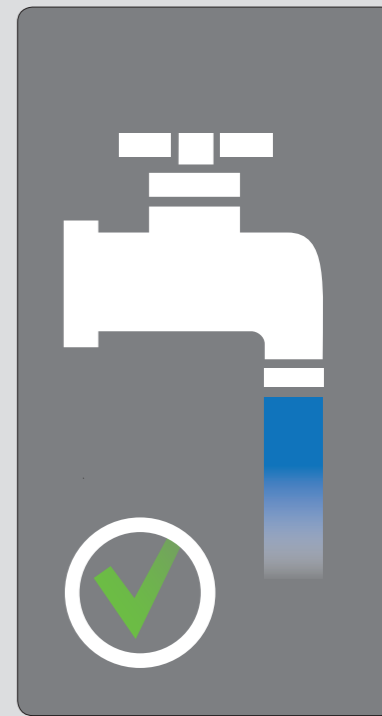

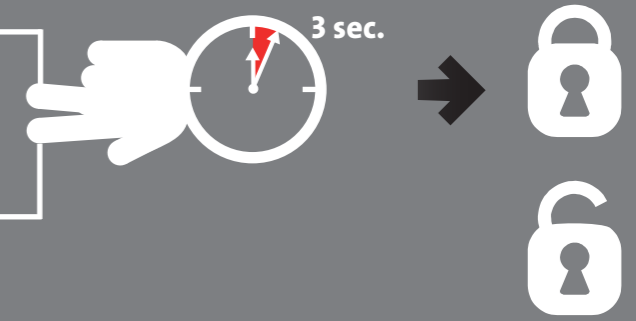
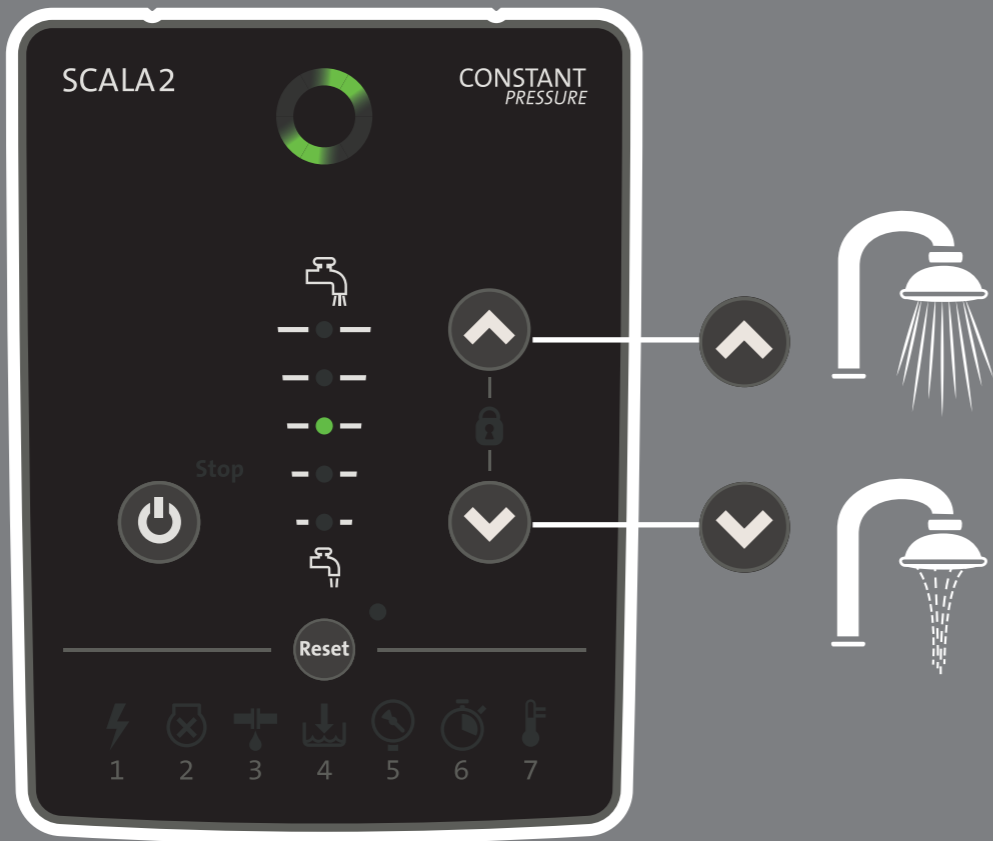
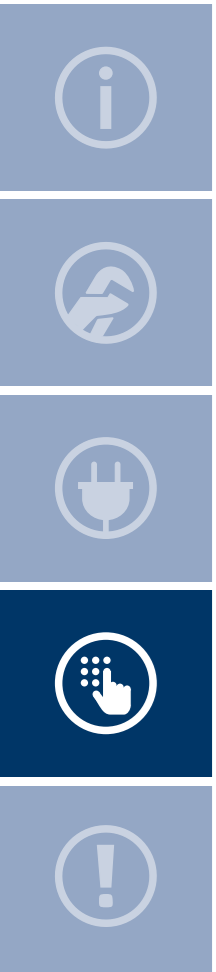



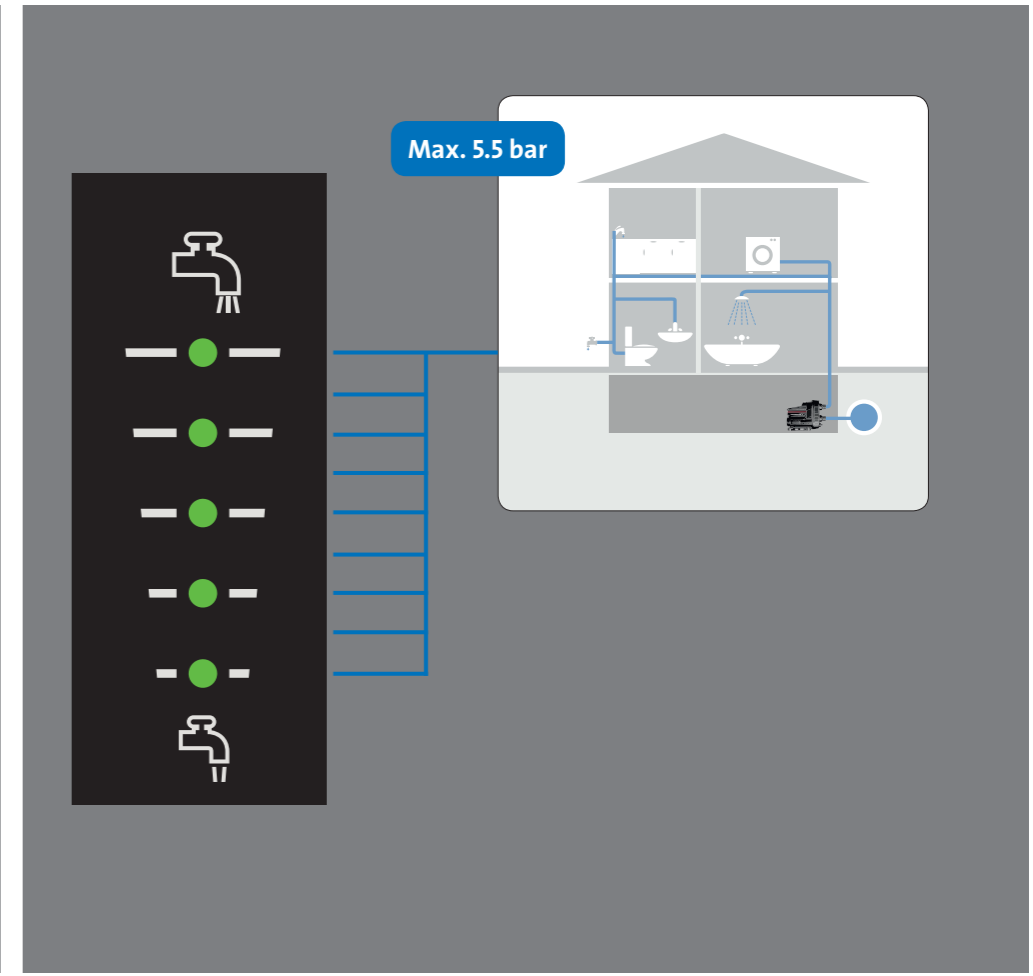
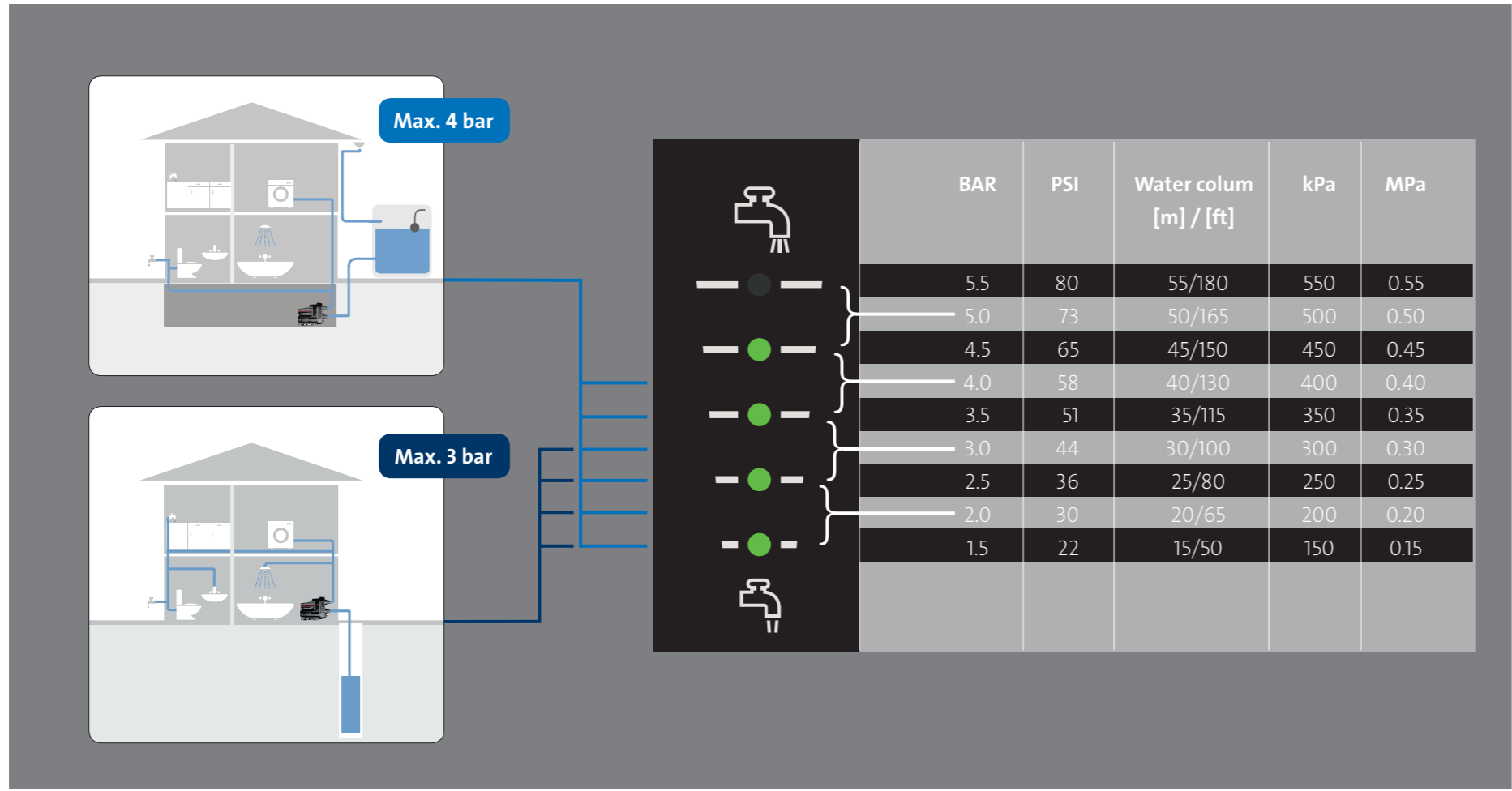
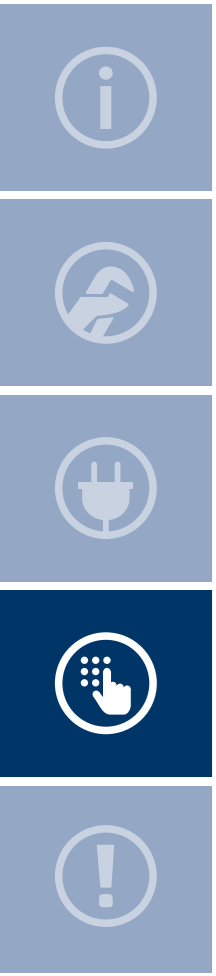

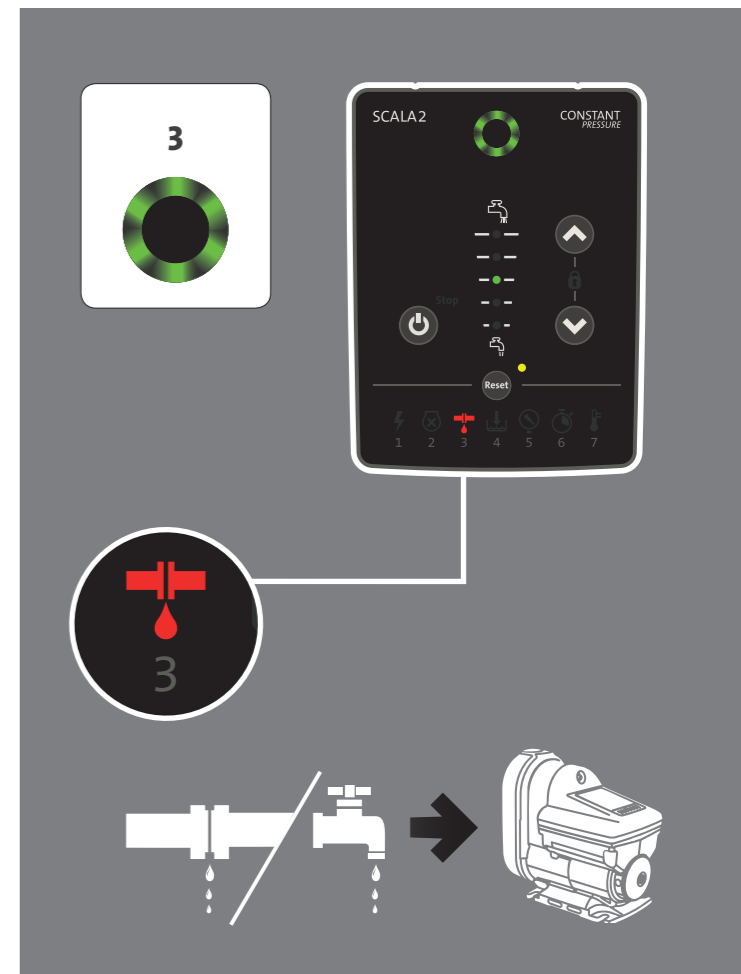
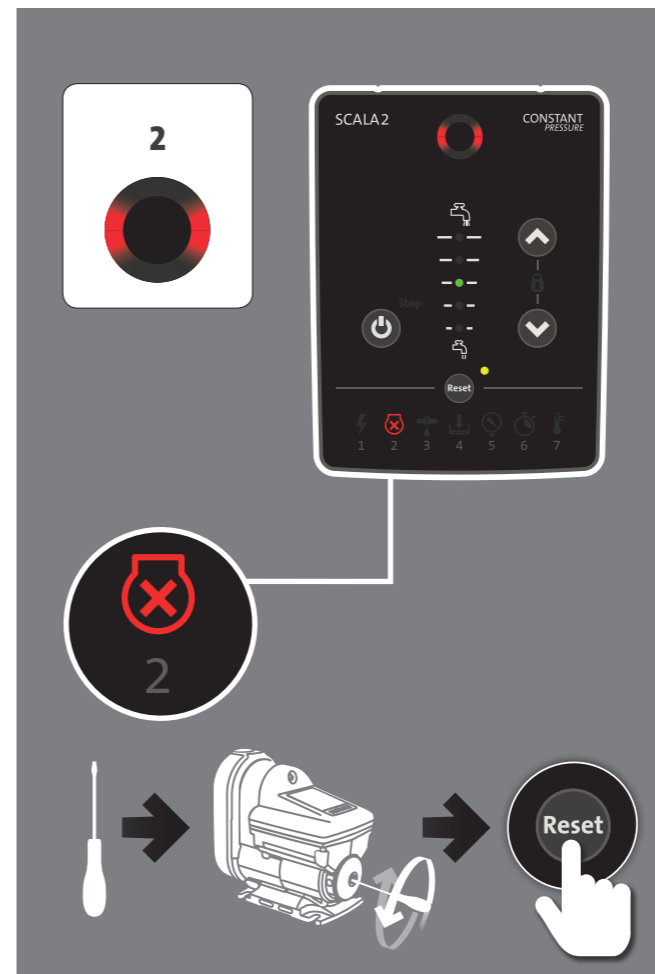
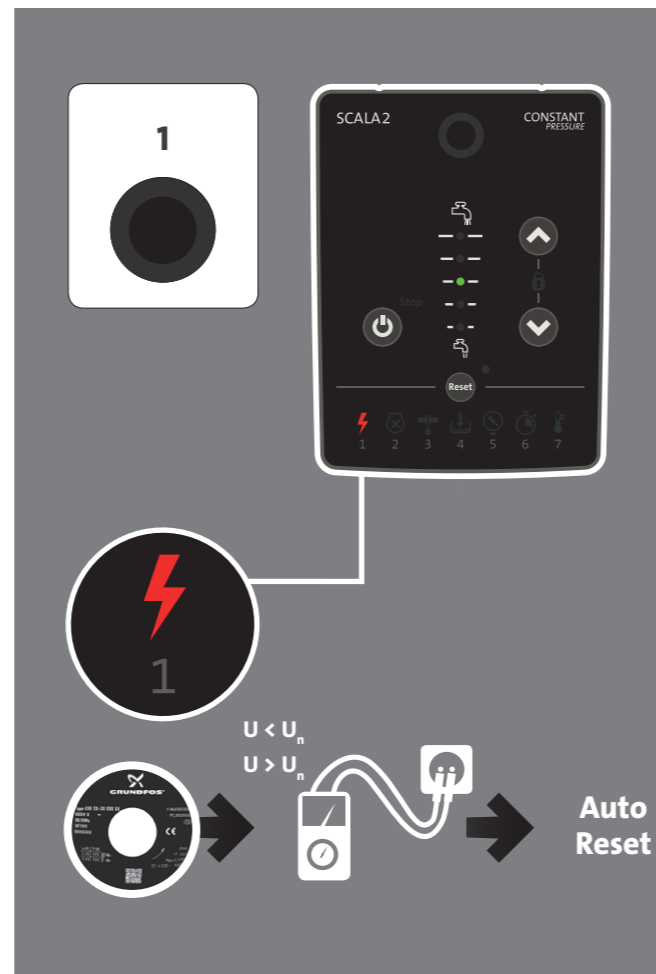
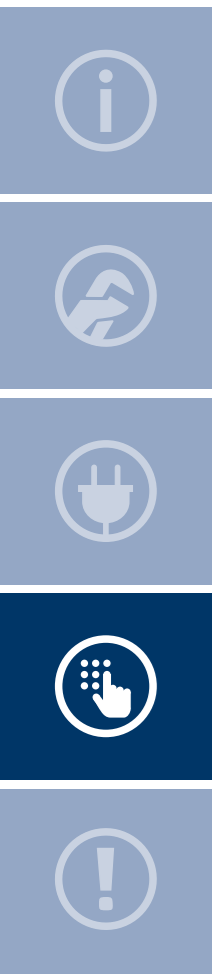

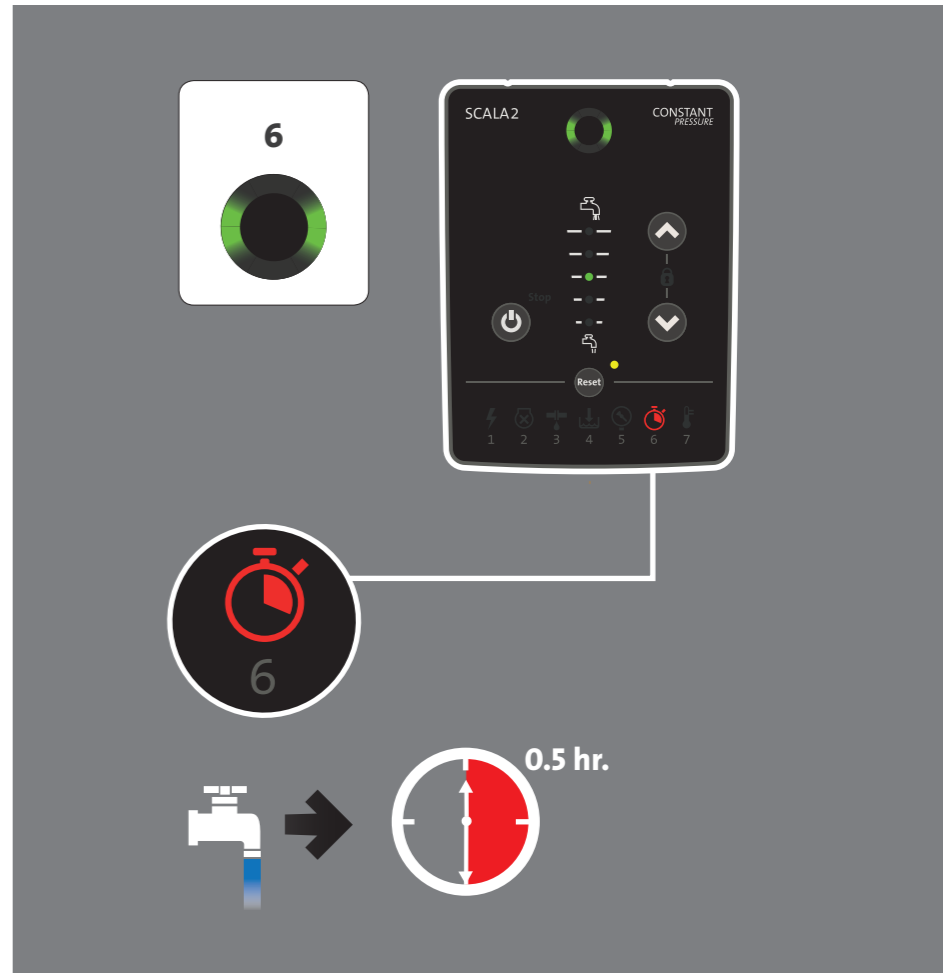
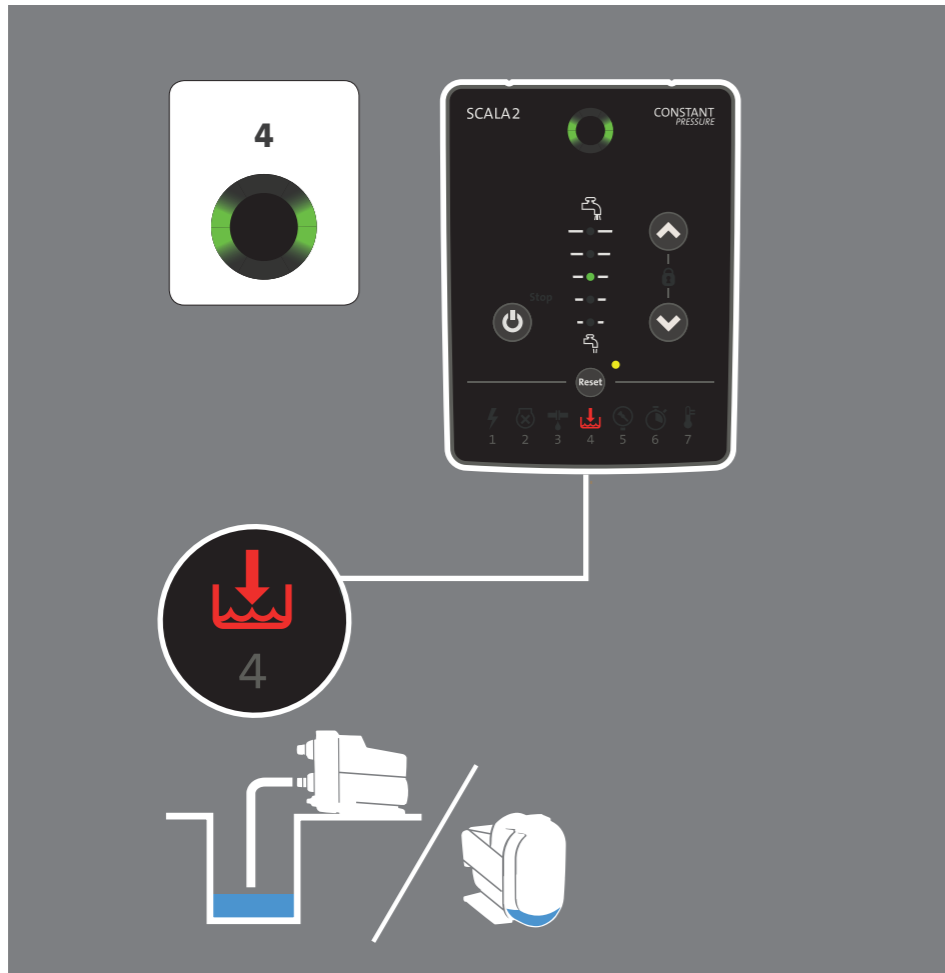
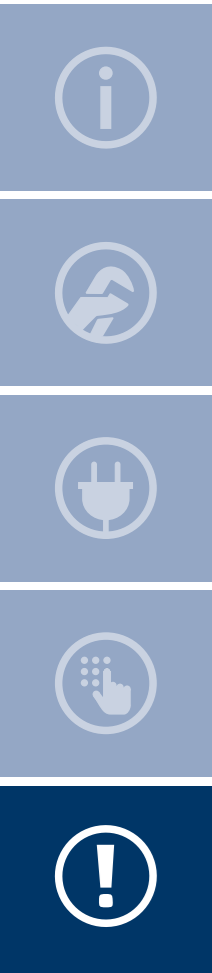

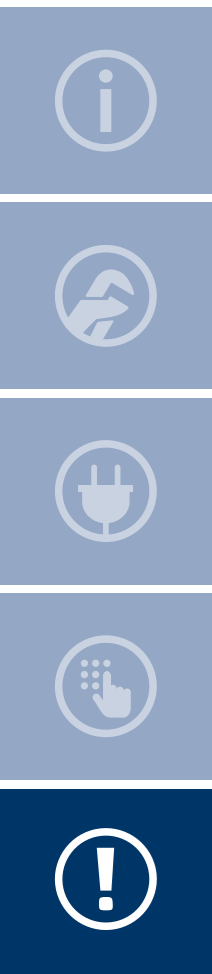

SCALA2 CONSTANT PRESSURE

7

7

GRUNDFOS X

1 2 3 4 5 6 7

[net.grundfos.com/qr/i/98880508](https://net.grundfos.com/qr/i/98880508)

be think innovate

---

98501666 0517

ECM: 1203706

**GRUNDFOS Holding A/S**  
Poul Due Jensens Vej 7  
DK-8850 Bjerringbro  
Tel: +45 87 50 14 00  
[www.grundfos.com](http://www.grundfos.com)

**GRUNDFOS** 

The name Grundfos, the Grundfos logo, and be think innovate are registered trademarks owned by Grundfos Holding A/S or Grundfos A/S, Denmark. All rights reserved worldwide.